

Content

Benefits and advantages.....	300
Approvals and marks	300
Ordering details	
R100.xx semiconductor contactors, single-phase	301
NEW R300.xx semiconductor contactors, three-phase.....	301
R111 solid-state relays, single-phase	302
R12x solid-state relays, single-phase	302
range completed R31x solid-state relays, three-phase	302
Accessories, heat sink KK.....	303
Technical data	
R100.xx semiconductor contactors, single-phase	304
R300.xx semiconductor contactors, three-phase.....	305
R111 solid-state relays, single-phase	306
R12x solid-state relays, single-phase	307
R31x solid-state relays, three-phase	308
Dimensioning of heat sinks	309
Operational current-temperature matrixes.....	310
Dimensional drawings	311

Semiconductor contactor R100.xx and R300.xx Solid-state relays R111, R12x and R31x

Benefits and advantages



2CDC305 027 F0004



2CDC305 028 F0004

R100.xx and R300.xx range

- Compact design
- Zero voltage or instantaneous tripping
- LED display
- Protected against electric shock
- Integrated heat sink
- Ready for use
- Mounting on 35 mm DIN rail or screw mounting on plate

Properties

- Rated operating current range 20 A, 30 A and 45 A
- DC control
- Single-pole, three-pole
- Switching by thyristors
- Peak inverse voltage 1200 V
- Insulation voltage > 4000 V
- Connecting terminals for 2 x 2.5 mm² or 1 x 4 mm²

Special properties

- The semiconductor relay R100.45-SG is internally protected against overload with overload signaling via signaling output.
- Cables with a conductor cross section up to 1 x 25 mm² can be connected to the output terminals of the semiconductor relays R100.45 and R100.45-SG.

Application

- Contactless and wear-free switching of ohmic and inductive 1-phase and 3-phase AC loads with high switching frequency.

Approvals

	R100.xx	R300.xx	R111	R12x	R31x
	■	■	■	■	■
	■	■			■
	■	□	■	■	□

Marks

	■	■		■	■
--	---	---	--	---	---

R111, R12x and R31x range

- Standard design
- Zero voltage tripping, radio interference suppressed
- LED display
- Screw mounting or snap-on mounting with adapter for 35 mm DIN rail according to DIN EN 50022

Properties

- R111 and R12x range - load side: Thyristors for AC-51 and AC-53 up to 690 V AC and 100 A
- R31x - load side: Alternistor for AC-51 and AC-53 up to 660 V AC and 75 A with internal RC circuit and overvoltage protection
- Electrical isolation by means of optocoupler between control circuit and load circuit
- R111 range with additional terminal cover
- Control side protected against reversed polarity

Special properties of R31x range

- Screw mounting

Application

- Contactless and wear-free switching of 1-phase and 3-phase AC loads up to a power factor of $\cos \varphi = 0.5$.

Semiconductor contactor R100.xx and R300.xx range

Ordering details



R100.20

2CDC 301 006 F 0003



R100.30-ZS

2CDC 301 007 F 0003



R100.45

2CDC 301 008 F 0003



R300.20

2CDC 301 005 F0004

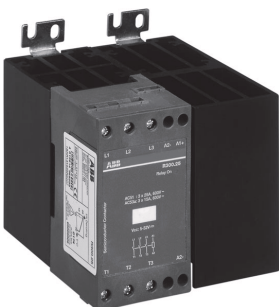

R300.25

2CDC 301 005 F0005

R100.xx range

- Compact design
- Zero voltage or instantaneous switching
- Rated operational voltage V_e 42-660 V AC
- Single-phase
- LED for status indication
- Current ranges: 20 A, 30 A, 45 A (thyristors)
- Integrated heat sink, ready for use
- Mounting on 35 mm DIN rail or screw mounting on plate
- Cage terminal with integrated protection against electric shock (touch proof)

Type	Rated control circuit voltage V_c	Rated operational current I_e	Order code	Pack. unit pieces	Price 1 piece	Weight 1 piece kg/lb
------	-------------------------------------	---------------------------------	------------	-------------------	---------------	----------------------

Zero voltage switching, width: 22.5 mm

R100.20	4-32 V DC	20 A	1SAR 111 020 R8607	1		0.25/0.55
----------------	-----------	------	---------------------------	---	--	-----------

Instantaneous switching, width: 22.5 mm

R100.30-IO	4-32 V DC	30 A	1SAR 113 030 R8607	1		0.25/0.55
-------------------	-----------	------	---------------------------	---	--	-----------

Zero voltage switching, width: 22.5 mm

R100.30-ZS	4-32 V DC	30 A	1SAR 111 030 R8607	1		0.25/0.55
-------------------	-----------	------	---------------------------	---	--	-----------

Zero voltage switching, width: 45 mm

R100.45	4-32 V DC	45 A	1SAR 111 045 R8607	1		0.49/1.08
----------------	-----------	------	---------------------------	---	--	-----------

Zero voltage switching, width: 45 mm, with integrated overtemperature protection and signalling output

R100.45-SG	4-32 V DC	45 A	1SAR 111 045 R9607	1		0.49/1.08
-------------------	-----------	------	---------------------------	---	--	-----------

R300.xx range

- Compact design
- Zero voltage switching
- Rated operational voltage V_e 40-660 V AC
- Three-phase
- LED for status indication
- Current ranges: 3 x 20 A, 3 x 25 A (thyristors)
- Integrated heat sink, ready for use
- Mounting on 35 mm DIN rail or screw mounting on plate
- Cage terminal with integrated protection against electric shock (touch proof)

Type	Rated control circuit voltage V_c	Rated operational current I_e	Order code	Pack. unit pieces	Price 1 piece	Weight 1 piece kg/lb
------	-------------------------------------	---------------------------------	------------	-------------------	---------------	----------------------

Zero voltage switching, width: 45 mm

R300.20	4.5-32 V DC	3x20 A	1SAR 131 020 R8207	1		0.38/0.84
----------------	-------------	--------	---------------------------	---	--	-----------

Zero voltage switching, width: 90 mm

R300.25	4.5-32 V DC	3x25 A	1SAR 131 030 R8207	1		0.68/0.15
----------------	-------------	--------	---------------------------	---	--	-----------

• Technical data 304 • Dimensional drawings 311

Solid-state relays

R111, R12x and R31x range

Ordering details



R111/45

2CDC 301 001 F 0003



R111/20

2CDC 301 002 F 0003



R120/25

2CDC 301 004 F 0003



R 126/25

1SAR 111 025 F 4609



R122/50

2CDC 301 005 F 0003

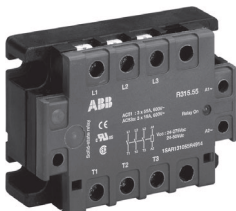

R 315/55

2CDC 301 031 F0004

range completed

R111 range

- Standard design
- Single-phase
- Zero voltage switching
- Cost-saving

Type	Rated control circuit voltage V_c	Rated operational current I_e	Order code	Pack. unit pieces	Price 1 piece	Weight 1 piece kg/lb
------	-------------------------------------	---------------------------------	------------	-------------------	---------------	----------------------

Rated operational voltage V_e : 24-280 V AC

R111/25	3-32 V DC	25 A	1SAR 111 025 R0102	1		0.11/0.24
R111/45	3-32 V DC	50 A	1SAR 111 050 R0102	1		0.11/0.24

Rated operational voltage V_e : 42-530 V AC

R111/20	3-32 V DC	25 A	1SAR 111 025 R0106	1		0.11/0.24
R111/40	3-32 V DC	50 A	1SAR 111 050 R0106	1		0.11/0.24
R111/90	3-32 V DC	90 A	1SAR 111 090 R0106	1		0.11/0.24

R12x range

- Standard design with protection against electric shock (touch proof)
- Zero voltage switching
- Single-phase
- LED for status indication
- Same basis dimensions and drilling distances as for the standard series (easy interchangeability)

Type	Rated control circuit voltage V_c	Rated operational current I_e	Order code	Pack. unit pieces	Price 1 piece	Weight 1 piece kg/lb
------	-------------------------------------	---------------------------------	------------	-------------------	---------------	----------------------

Rated operational voltage V_e : 24-265 V AC

R120/25	3-32 V DC	25 A	1SAR 111 025 R4609	1		0.06/0.13
R120/50	3-32 V DC	50 A	1SAR 111 050 R4609	1		0.06/0.13

Rated operational voltage V_e : 42-530 V AC

R121/25	4-32 V DC	25 A	1SAR 111 025 R4606	1		0.06/0.13
R121/50	4-32 V DC	50 A	1SAR 111 050 R4606	1		0.06/0.13
R121/75	4-32 V DC	75 A	1SAR 111 075 R4606	1		0.10/0.22
R121/100	4-32 V DC	100 A	1SAR 111 100 R4606	1		0.10/0.22
R126/25	24-265 V AC / 24-48 V DC	25 A	1SAR 111 025 R4707	1		0.06/0.13
R126/50	24-265 V AC / 24-48 V DC	50 A	1SAR 111 050 R4707	1		0.06/0.13
R126/75	24-265 V AC / 24-48 V DC	75 A	1SAR 111 075 R4707	1		0.10/0.22
R126/100	24-265 V AC / 24-48 V DC	100 A	1SAR 111 100 R4707	1		0.10/0.22

Rated operational voltage V_e : 42-660 V AC

R122/50	4-32 V DC	50 A	1SAR 111 050 R4607	1		0.06/0.13
R122/75	4-32 V DC	75 A	1SAR 111 075 R4607	1		0.10/0.22
R122/100	4-32 V DC	100 A	1SAR 111 100 R4607	1		0.10/0.22

R31x range

- Standard design
- Zero voltage switching
- Rated operational voltage V_e 12-660 V AC
- LED for status indication
- Three-phase
- Integrated protection against electric shock (no additional terminal cover necessary)
- Same basis dimensions and drilling distances as for the standard series (easy interchangeability)

Type	Rated control circuit voltage V_c	Rated operational current I_e	Order code	Pack. unit pieces	Price 1 piece	Weight 1 piece kg/lb
------	-------------------------------------	---------------------------------	------------	-------------------	---------------	----------------------

R311/25	4-32 V DC	25 A	1SAR 131 025 R4814	1		0.38/0.84
R311/55	4-32 V DC	55 A	1SAR 131 055 R4814	1		0.38/0.84
R311/75	4-32 V DC	75 A	1SAR 131 075 R4814	1		0.38/0.84
R315/25	24-275 V AC, 24-50 V DC	25 A	1SAR 131 025 R4914	1		0.38/0.84
R315/55	24-275 V AC, 24-50 V DC	55 A	1SAR 131 055 R4914	1		0.38/0.84
R315/75	24-275 V AC, 24-50 V DC	75 A	1SAR 131 075 R4914	1		0.38/0.84

- Technical data 306
- Dimensional drawings 311
- Operational current at temperature diagrams 310

Solid-state relays - Accessories

Heat sink KK

Ordering details



KK-2,6

2CDC301 011 F 0003



KK-R111-1,5

2CDC301 013 F 0003

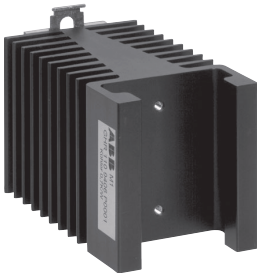

KK-R111-0,7

2CDC-301 014 F 0003

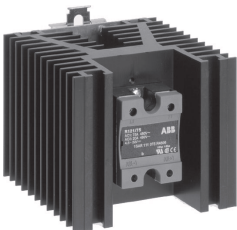

HS 75/0,5

1SAR 110 100 F3606

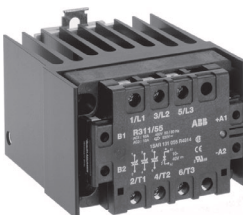

HDS 50/0,8

1SVC 110 000 F0609

Heat sink for single-phase solid-state relays R111, R120, R121, R122, R126

Type	Description	Order code	Pack. unit pieces	Price 1 piece	Weight 1 piece kg/lb
------	-------------	------------	-------------------	---------------	----------------------

For screw mounting on mounting plate

KK-2,6	Heat sink 2,6 K/W ¹⁾	GHR 110 9401 P0001	1		0.12/0.26
KK-1,8	Heat sink 1,8 K/W ¹⁾	GHR 110 9401 P0002	1		0.20/0.44
KK-0,7	Heat sink 0,7 K/W ¹⁾	GHR 110 9404 P0001	1		0.65/1.43

For DIN rail mounting

KK-R111-2,1	Heat sink 2,1 K/W ¹⁾	GHR 110 9402 P0001	1		0.29/0.64
KK-R111-1,5	Heat sink 1,5 K/W ¹⁾	GHR 110 9405 P0001	1		0.42/2.20
KK-R111-0,7	Heat sink 0,7 K/W ¹⁾	GHR 110 9406 P0001	1		1.02/2.20
KK-R111-0,5	Heat sink 0,5 K/W ¹⁾	GHR 110 9407 P0001	1		1.30/2.86

Heat sink for three-phase solid-state relays R311, R315

For DIN rail mounting

KK-R311-0,8	Heat sink 0,8 K/W ¹⁾	GHR 310 9401 P0001	1		1,00/2.20
--------------------	---------------------------------	---------------------------	---	--	-----------

Further accessories

	Terminal cover for R111, R115	GHR 110 6605 P0001	1		0.05/0.11
	Rapid-fastening plate for R1xx	GHR 110 1105 R0001	1		0.045/0.01
	fastening plate for R31x	GHR 310 1105 R0001	1		0.05/0.11
EMV - 100	EMC filter for single-phase solid-state relays	GHR 110 0000 R0001	1		0.10/0.22
EMV - 300	EMC filter for three-phase solid-state relays	GHR 310 0000 R0001	1		0.10/0.22
TP-01	Heat transfer foil for single-phase relays	GHR 110 9500 P0001	1		0.001/0.002
TP-03	Heat transfer foil for three-phase relays	GHR 310 9500 P0001	1		0.005/0.011

¹⁾ Use heat transfer paste or heat transfer foil TP-01 or TP-03 when mounting solid-state relays.

Semiconductor contactors

R100.xx range

Technical data

Type	R100.20	R100.30-IO	R100.30-ZS	R100.45	R100.45-SG
Output circuit					
Switching element	Thyristor				
Rated operational voltage V_e (V_{effmax})	42-660 V AC				
Period. peak inverse voltage (V_{peak})	1200 V_{pp}				
Rated operational current at $T_a = 25\text{ }^\circ\text{C}$	AC-51	20 A AC	30 A AC	45 A AC	
	AC-53a	5 A AC	15 A AC	20 A AC	
Operating frequency	45-65 Hz				
Max. off-state leakage current (at V_{max} and $T = 25\text{ }^\circ\text{C}$)	< 3 mA_{rms}				
Minimum load current	350 mA	150 mA	150 mA	150 mA	
Max. surge current I_{TSM} ($t = 10$ ms)	250 A	400 A	400 A	1150 A	
Max. overcurrent ($t = 1$ s)	< 35 A AC	< 125 A AC	< 125 A AC	< 125 A AC	
Max. load integral $\int i^2 dt$ ($t = 10$ ms)	310 A^2s	1800 A^2s	1800 A^2s	6600 A^2s	
Conducting state voltage at I_{max} and $T = 25\text{ }^\circ\text{C}$ (V_{peak})	1.6 V_{rms}				
Critical current gradient di/dt	≥ 10 A/ μs	≥ 100 A/ μs	≥ 150 A/ μs	≥ 150 A/ μs	
Permissible commutating voltage gradient du/dt	500 V/ μs				
Permissible static voltage gradient du/dt	500 V/ μs				
Input circuit					
Rated control circuit voltage	4-32 V DC	4-32 V DC	4-32 V DC	4-32 V DC	4-32 V DC
Make voltage	3.8 V DC	3.8 V DC	4.25 V DC	4.25 V DC	3.8 V DC
Inverse polarity voltage	32 V DC				
Break voltage	1.2 V DC	1.2 V DC	1 V DC	1 V DC	1.2 V DC
Input current (at V_{max})	12 mA	12 mA	15 mA	15 mA	12 mA
Turn-on time max.	1 period	1 ms	1 period	1 period	1 period
Turn-off time max.	1 period				
General data					
Power factor ($\cos \varphi$)	≥ 0.5 (at 600 V AC)				
Operating temperature	-30...+80 $^\circ\text{C}$				
Storage temperature	-40...+100 $^\circ\text{C}$				
Barrier-layer temperature	125 $^\circ\text{C}$				
Proof voltage	4000 V				
Dielectric strength	4000 V				
Wire size	input terminals	max. 2 x 2.5 mm^2 / 1 x 4 mm^2			
	output terminals	2 x 2.5 mm^2 / 1 x 4 mm^2 or 1 x 25 mm^2 (R100.45)			

Load limit curves

Operational current at ambient temperature

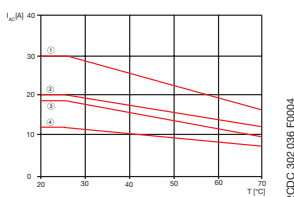

R100.20 / R100.30

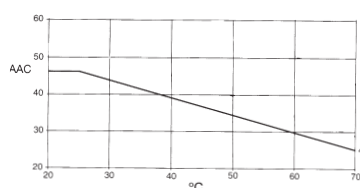

R100.45

Dissipation at operational current

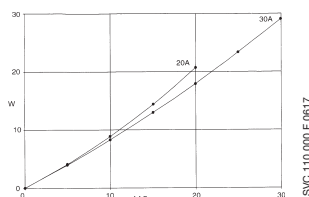

R100.20 / R100.30

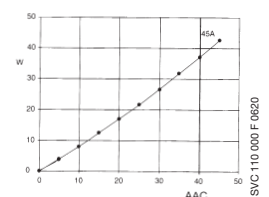

R100.45

Semiconductor contactors

R300.xx range

Technical data

Type	R300.20	R300.25
Output circuit		
Switching element	Thyristor	
Rated operational voltage	40-660 V AC	
Period. peak inverses voltage (V_{peak})	1200 V _{pp}	
Rated operational current at $T_a = 25\text{ °C}$	AC-51	3x20 A
	AC-53a	3x15 A
Operating frequency	45-65 Hz	
Max. off-state leakage current (at V_{rms} and operational frequency)	< 3 mA	
Minimum load current	150 mA	
Max. surge current ($T = 25\text{ °C}$, $t = 10\text{ ms}$)	600 Apk	
Max. overcurrent ($t = 1\text{ s}$)	< 125 A	
Max. load integral $\int i^2 dt$ ($t = 10\text{ ms}$)	1800 A ² s	
Conducting state voltage at I_{rms}	1.6 V _{rms}	
Critical current gradient di/dt	$\geq 100\text{ A}/\mu\text{s}$	
Permissible commutating voltage gradient du/dt	500 V/ μs	
Permissible static voltage gradient du/dt	500 V/ μs	
Input circuit		
Rated control circuit voltage	5-32 V DC	
Make voltage	4.7 V DC	
Inverse polarity voltage	-32 V DC	
Break voltage	1.2 V DC	
Maximum input current	24 mA	
Turn-on time	< 1 period	
Turn-off time	< 1 period	
General data		
Power factor ($\cos \varphi$)	≥ 0.5 (at 600 V AC)	
Operating temperature	-30...+70 °C	
Storage temperature	-40...+80 °C	
Rated insulation voltage	Input to output	$\geq 4000\text{ V}_{rms}\text{ AC}$
	Output to case	$\geq 4000\text{ V}_{rms}\text{ AC}$
Conductor cross section	rigid	0.5-4.0 mm ² (20-12 AWG)
	stranded with wire end ferrules	0.5-2x2.5 mm ² (20-2x12 AWG)
Approvals	UL, cULus CSA (pending)	

Load limit curves

Derating curve

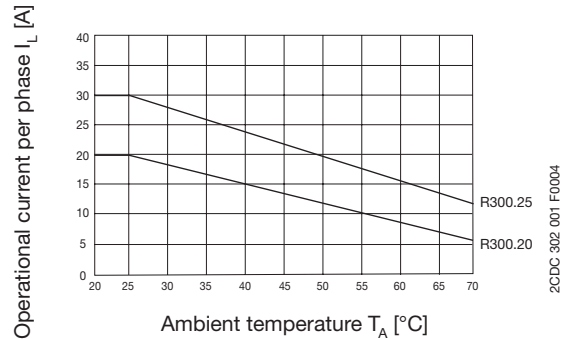

Dissipation curve

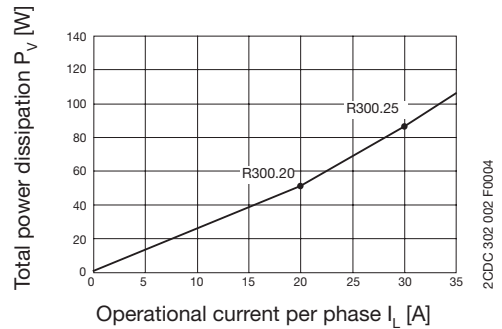

Solid-state relays

R111 range

Technical data

Type	R111/25	R111/45	R111/20	R111/40	R111/90
Output circuit					
Switching element	Thyristor				
Rated operational voltage V_e ($V_{eff,max}$)	24-280 V AC		42-530 V AC		
Period. peak inverse voltage (V_{peak})	650 V _{pp}		1200 V _{pp}		
Rated operational current	AC-51	25 A _{rms}	50 A _{rms}	25 A _{rms}	50 A _{rms}
	AC-53a	5 A _{rms}	15 A _{rms}	5 A _{rms}	15 A _{rms}
Operating frequency	45-65 Hz				
Max. off-state leakage current (at V_{max} and $T = 25\text{ °C}$)	3 mA				
Minimum load current	20 mA _{rms}				
Max. surge current I_{TSM} ($t = 20$ ms)	250 A	600 A	250 A	600 A	1000 A
Max. overcurrent ($t = 1$ s)	55 A	125 A	55 A	125 A	150 A
Max. load integral $\int i^2 dt$ ($t = 10$ ms)	310 A ² s	1800 A ² s	310 A ² s	1800 A ² s	5000 A ² s
Conducting state voltage at I_{max} and $T = 25\text{ °C}$ (V_{peak})	1.6 V				
Permissible voltage gradient du/dt	500 V/ μ s				
Critical current gradient di/dt	100 A/s				
Thermal resistance barrier/base max.	1.25 K/W	0.65 K/W	1.25 K/W	0.65 K/W	0.3 K/W
Thermal resistance barrier/ambient max.	12 K/W				
Input circuit					
Rated control circuit voltage	3-32 V DC				
Make voltage	3 V DC				
Break voltage	1 V DC				
Input impedance	1.5 k Ω				
Max. input current (at V_{max})	22 mA				
Turn-on time max.	0.5 period				
Turn-off time max.	0.5 period				
Input circuit					
Power factor ($\cos \varphi$)	0.5-1 ¹⁾				
Operating temperature	-20...+70 °C				
Barrier-layer temp.	125 °C				
Storage temperature	-40...+100 °C				
Proof voltage	4000 V				
Dielectric strength	4000 V				

7

Circuit diagram R111

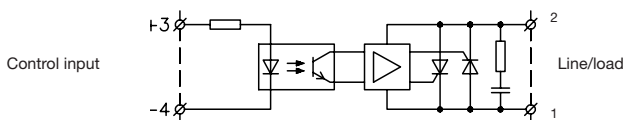

2CDC 302 014 F0004

¹⁾ If the limit values are observed, the solid-state relays are suitable for switching inductive loads.

Solid-state relays

R12x range

Technical data

Type	R120/25	R120/50	R121/25 R126/25	R121/50 R126/50	R121/75 R126/75	R121/100 R126/100	R122/50	R122/75	R122/100	
Output circuit										
Switching element	Thyristor									
Rated operational voltage V_e ($V_{rms,max}$)	24-265 V AC		42-530 V AC				42-660 V AC			
Period. peak inverse voltage (V_{peak})	650 V_{pp}		1200 V_{pp}				1600 V_{pp}			
Rated operational current	AC-51	25 A_{rms}	50 A_{rms}	25 A_{rms}	50 A_{rms}	75 A_{rms}	100 A_{rms}	50 A_{rms}	75 A_{rms}	100 A_{rms}
	AC-53a	5 A_{rms}	15 A_{rms}	5 A_{rms}	15 A_{rms}	20 A_{rms}	30 A_{rms}	15 A_{rms}	20 A_{rms}	30 A_{rms}
Operating frequency	45-65 Hz									
Max. off-state leakage current (at V_{max} and $T = 25\text{ °C}$)	3 mA									
Minimum load current	150 mA_{rms}									
Max. surge current I_{TSM} ($t = 10\text{ ms}$)	250 A	600 A	250 A	600 A	1000 A	1500 A	600 A	1000 A	1500 A	
Max. overcurrent ($t = 1\text{ s}$)	55 A	125 A	55 A	125 A	150 A	200 A	125 A	150 A	200 A	
Max. load integral $\int i^2 dt$ ($t = 10\text{ ms}$)	310 A^2s	1800 A^2s	310 A^2s	1800 A^2s	6600 A^2s	18000 A^2s	1800 A^2s	6600 A^2s	18000 A^2s	
Conducting state voltage at I_{max} and $T = 25\text{ °C}$ (V_{peak})	1.6 V									
Permissible voltage gradient du/dt	500 V/ μs									
Critical current gradient di/dt	100 A/s									
Thermal resistance barrier/base max.	0.8 K/W	0.5 K/W	0.8 K/W	0.5 K/W	0.2 K/W	0.2 K/W	0.5 K/W	0.2 K/W	0.2 K/W	
Thermal resistance barrier/ambient max.	20 K/W		20 K/W				15 K/W	20 K/W		15 kW
Type	R120		R121		R122		R126			
Output circuit										
Rated control circuit voltage	3-32 V DC		4-32 V DC		4-32 V DC		24-265 V AC / 24-48 V DC			
Make voltage			3.75 V DC				22 V AC/DC			
Break voltage			1 V DC				6 V AC/DC			
Input impedance			1.5 $k\Omega$				44 $k\Omega$			
Max. input current (at V_{max})			10 mA				5 mA			
Max. turn-on time	< 0.5 period	for all DC supplied types								
	< 1 period	for all AC supplied types								
Max. turn-off time	< 0.5 period	for all DC supplied types								
	< 2 periods	for all AC supplied types								
Type	R12x									
General data										
Power factor ($\cos \varphi$)	0.5-1 ¹⁾									
Operating temperature	-20...+70 °C									
Barrier-layer temp.	125 °C									
Storage temperature	-40...+100 °C									
Proof voltage	4000 V									
Dielectric strength	4000 V									

Circuit diagram R12x

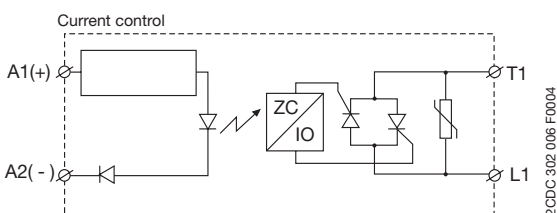

¹⁾ If the limit values are observed, the solid-state relays are suitable for switching inductive loads.

Solid-state relays

R31x range

Technical data

Type	R311/25	R311/55	R311/75	R315/25	R315/55	R315/75
Output circuit						
Switching element	Alternistor					
Rated operational voltage V_e	42-660 V AC					
Period. peak inverse voltage (V_{peak})	1200 V _{pp}					
Rated operational current at $T_a = 25\text{ °C}$	AC-51	25 A _{rms}	55 A _{rms}	75 A _{rms}	25 A _{rms}	55 A _{rms}
	AC-53a	5 A _{rms}	15 A _{rms}	20 A _{rms}	5 A _{rms}	20 A _{rms}
Operating frequency	45-65 Hz					
Max. off-state leakage current (at V_{max} and $T_a = 25\text{ °C}$)	< 3 mA					
Minimum load current	150 mA _{rms}					
Max. surge current I_{TSM} (t = 10 ms)	230 As	600 As	1000 As	230 As	600 As	1000 As
Max. overcurrent (t = 1 s)	37 A	< 125 A	< 150 A	37 A	< 125 A	< 150 A
Max. load integral \int (t = 10 ms)	265 A ² s	1800 A ² s	6600 A ² s	265 A ² s	1800 A ² s	6600 A ² s
Conducting state voltage	$\leq 1.6 V_{rms}$					
Permissible voltage gradient du/dt	$\geq 500 V/\mu s$					
Critical current gradient di/dt at 50 Hz	$\geq 100 A/\mu s$					
Input circuit (all data at $T_a = 25\text{ °C}$)						
Rated control circuit voltage	4-32 V DC			24-275 V AC, 24-50 V DC		
Make voltage	3.8 V DC			18 V AC, 20 V DC		
Break voltage	1.2 V DC			9 V AC		
Max. input current (at V_{max})	$\leq 23\text{ mA}$			$\leq 15\text{ mA}$		
Turn-on time delay (at 50 Hz)	10 ms			20 ms		
Turn-off time delay (at 50 Hz)	10 ms			30 ms		
General data						
Temperature range	operation		-30...+80 °C			
	storage		-40...+100 °C			
Barrier-layer temperature	$\leq \pm 125\text{ °C}$					
Degree of protection	IP 10					
Wire size	control circuit		2 x 2.5 mm ² (2 x 14 AWG)			
	load circuit		2 x 6 mm ² (2 x 8 AWG)			
Torque	control circuit		$\leq 0.5\text{ Nm}$			
	load circuit		2.5 Nm			
Isolation data						
Rated isolation voltage solid-state relay - enclosure	$\geq 400\text{ V AC}_{rms}$					
Test voltage	4000 V					
Dielectric strenght	4000 V					
Overvoltage category	III					
Protection class	2					

Solid-state relays

Heat sink dimensioning for solid-state relays

Procedure for choosing a solid-state relay

Choosing the suitable solid-state relay is easy to do, if the following 4 questions are answered.

1. How much is the maximum operational current?
2. Which control circuit voltage is used?
3. Which operational voltage is required?
4. Is the device operated continuously or in duty cycles?

Knowing these data you can easily choose a suitable relay by means of the technical data specified in this catalog.

Procedure for choosing a suitable heat sink

After having selected the relay, a heat sink suitable for the specific application has to be chosen. For this, the following two questions are of importance.

1. How much is the maximum operational current?
2. How much is the ambient temperature during operation?

If you know the ambient temperature during operation, you can determine the thermal resistance between the bottom of the solid-state relay and the environment using a matrix as it is shown below. The respective matrixes for the other relays are shown on the following pages. Knowing the thermal resistance and the technical data of the heat sink, you can then choose a suitable heat sink.

operational current [A]	thermal resistance [K/W]						power dissipation [W]
	20	30	40	50	60	70	
50,0	1,03	0,86	0,70	0,53	0,37	0,20	61
45,0	1,27	1,09	0,90	0,71	0,52	0,33	53
40,0	1,54	1,32	1,10	0,89	0,67	0,45	46
35,0	1,85	1,59	1,34	1,08	0,82	0,57	39
30,0	2,26	1,95	1,65	1,34	1,03	0,72	33
25,0	2,85	2,47	2,08	1,70	1,32	0,94	26
20,0	3,73	3,24	2,75	2,26	1,77	1,27	20
15,0	5,22	4,54	3,86	3,19	2,51	1,83	15
10,0	8,21	7,16	6,11	5,05	4,00	2,95	10
5,0	17,2	15,0	12,9	10,7	8,51	6,33	5

T_a ambient temperature [°C]

2CDC 302 008 F0004

The selection of the heat sink directly affects the warming of the relay.

$$\text{Relay temperature } T = \text{ambient temperature} + (\text{dissipation} \cdot \text{thermal resistance})$$

The calculated value for the relay temperature should not exceed 100 °C. Otherwise, danger of fire as well as danger of damage to the device exist.

Example

Choosing the solid-state relay:

1. The maximum operational current is 30 A
2. A control circuit voltage of 230 V AC is used
3. The operational voltage is 400 V AC
4. The relay shall be used at continuous operation

→ Possible relays:

R 126/50 - R 126/75 - R 126/100

Chosen relay:

R 126/50

Choosing the heat sink:

1. The maximum operational current is 30 A
2. The ambient temperature during operation is 40 °C

The thermal resistance can be determined using the operational current-ambient temperature matrix.

The Y axis of the diagram shows the operational current, the X axis shows the ambient temperature in °C. The thermal resistance can be read at the cross-point of the operational current with the ambient temperature. In our example the thermal resistance is 1.65 K/W (kelvin/watt).

Consequently, the required heat sink must have a value of at least 1.65 K/W. Here it has to be observed that the quality of the heat sink increases with a reduction of the temperature/power ratio which means that a heat sink with a ratio of 0.5 K/W provides better heat dissipation than a heat sink with a ratio of 1.5 K/W.

The power dissipation can be read from the right column of the matrix. In our example it is 33 W.

Knowing the thermal resistance, you can now choose a suitable heat sink using the technical data.

Example 1: Heat sink KK-R111-2,1

$$T = 40 \text{ °C} + (33 \text{ W} + 2.1 \text{ K/W}) = 40 \text{ °C} + 69.3 \text{ °C} = 109.3 \text{ °C} \quad \text{Too hot!}$$

Example 2: Heat sink KK-R111-1,5

$$T = 40 \text{ °C} + (33 \text{ W} + 1.5 \text{ K/W}) = 40 \text{ °C} + 49.5 \text{ °C} = 89.5 \text{ °C} \quad \text{OK!}$$

Example 3: Heat sink KK-R111-0,5

$$T = 40 \text{ °C} + (33 \text{ W} + 0.5 \text{ K/W}) = 40 \text{ °C} + 16.5 \text{ °C} = 56.5 \text{ °C} \quad \text{OK!}$$

Due to reasons of space and costs, example 2 is the most commonly used case.

The calculated values apply for continuous duty; during cycling the heating is lower depending on the duty cycle.

Solid-state relays

Operational currents related to the ambient temperature, heat sink dimensioning

R111 range

operational current I_b [A]	thermal resistance [K/W]						power dissipation P_V [W]
25	2	1.7	1.4	1	0.71	0.40	32
22.5	2.5	2.1	1.8	1.4	1	0.66	27
20	3.1	2.7	2.3	1.9	1.4	1	23
17.5	4	3.5	3	2.5	2	1.4	20
15	4.9	4.3	3.7	3.1	2.5	1.9	16
12.5	6.2	5.4	4.6	3.9	3.1	2.3	13
10	8.1	7.1	6.1	5.1	4	3	10
7.5	11.3	9.9	8.5	7.1	5.6	4.2	7
5	-	15.6	13.3	11.1	8.9	6.7	5
2.5	-	-	-	-	18.7	14	2
	20	30	40	50	60	70	

R111/20 - R111/25

2CDC 302 011 F0004

operational current I_b [A]	thermal resistance [K/W]						power dissipation P_V [W]
50	0.92	0.76	0.60	0.45	0.29	-	63
45	1.2	0.99	0.80	0.62	0.44	0.26	55
40	1.5	1.3	1.1	0.85	0.63	0.42	47
35	1.9	1.6	1.4	1.1	0.89	0.63	40
30	2.4	2.1	1.8	1.5	1.2	0.91	33
25	3	2.7	2.3	1.9	1.5	1.1	26
20	3.9	3.5	3	2.5	2	1.5	20
15	5.5	4.8	4.1	3.4	2.7	2.1	15
10	8.6	7.5	6.4	5.4	4.3	3.2	9
5	17.9	15.6	13.4	11.2	8.9	6.7	4
	20	30	40	50	60	70	

R111/40 - R111/45

2CDC 302 012 F0004

operational current I_b [A]	thermal resistance [K/W]						power dissipation P_V [W]
90	0.63	0.53	0.42	0.32	-	-	97
80	0.81	0.69	0.57	0.45	0.33	-	84
70	1	0.89	0.75	0.61	0.47	0.33	71
60	1.3	1.2	1	0.83	0.66	0.49	59
50	1.7	1.5	1.3	1.1	0.85	0.64	47
40	2.2	1.9	1.7	1.4	1.1	0.83	36
30	3.1	2.7	2.3	1.9	1.5	1.2	26
20	4.8	4.2	3.6	3	2.4	1.8	17
10	10	8.8	7.5	6.3	5	3.8	8
	20	30	40	50	60	70	

R111/90

2CDC 302 013 F0004

R12x range

operational current I_b [A]	thermal resistance [K/W]						power dissipation P_V [W]
25.0	2.70	2.34	1.98	1.61	1.25	0.89	28
22.5	3.10	2.69	2.28	1.86	1.45	1.04	24
20.0	3.61	3.13	2.65	2.18	1.70	1.23	21
17.5	4.26	3.70	3.14	2.59	2.03	1.47	18
15.0	5.14	4.47	3.80	3.14	2.47	1.80	15
12.5	6.38	5.56	4.73	3.91	3.09	2.27	12
10.0	8.25	7.19	6.14	5.08	4.02	2.97	9
7.5	11.4	9.94	8.49	7.04	5.59	4.14	7
5.0	17.7	15.4	13.2	11.0	8.74	6.51	4
2.5	-	-	-	-	18.2	13.6	2
	20	30	40	50	60	70	

R120/25 - R121/25 - R126/25

2CDC 302 007 F0004

operational current I_b [A]	thermal resistance [K/W]						power dissipation P_V [W]
50.0	1.03	0.86	0.70	0.53	0.37	0.20	61
45.0	1.27	1.09	0.90	0.71	0.52	0.33	53
40.0	1.54	1.32	1.10	0.89	0.67	0.45	46
35.0	1.85	1.59	1.34	1.08	0.82	0.57	39
30.0	2.26	1.95	1.65	1.34	1.03	0.72	33
25.0	2.85	2.47	2.08	1.70	1.32	0.94	26
20.0	3.73	3.24	2.75	2.26	1.77	1.27	20
15.0	5.22	4.54	3.86	3.19	2.51	1.83	15
10.0	8.21	7.16	6.11	5.05	4.00	2.95	10
5.0	17.2	15.0	12.9	10.7	8.51	6.33	5
	20	30	40	50	60	70	

R120/50 - R121/50 - R122/50 - R126/50

2CDC 302 008 F0004

operational current I_b [A]	thermal resistance [K/W]						power dissipation P_V [W]
75.0	0.91	0.78	0.65	0.52	0.39	0.26	77
67.5	1.10	0.96	0.81	0.66	0.51	0.36	68
60.0	1.34	1.17	1.00	0.83	0.66	0.49	59
52.5	1.60	1.40	1.20	1.00	0.80	0.60	50
45.0	1.93	1.68	1.44	1.20	0.96	0.72	42
37.5	2.38	2.08	1.78	1.49	1.19	0.89	34
30.0	3.06	2.68	2.30	1.91	1.53	1.15	26
22.5	4.21	3.68	3.16	2.63	2.10	1.58	19
15.0	6.51	5.70	4.88	4.07	3.26	2.44	12
7.5	13.5	11.77	10.09	8.41	6.73	5.04	6
	20	30	40	50	60	70	

R121/75 - R122/75 - R126/75

2CDC 302 009 F0004

operational current I_b [A]	thermal resistance [K/W]						power dissipation P_V [W]
100.0	0.54	0.45	0.36	0.27	0.18	0.09	111
90.0	0.68	0.58	0.47	0.37	0.27	0.17	97
80.0	0.86	0.74	0.62	0.50	0.38	0.26	84
70.0	1.08	0.94	0.80	0.66	0.52	0.38	71
60.0	1.37	1.20	1.03	0.85	0.68	0.51	59
50.0	1.70	1.49	1.28	1.06	0.85	0.64	47
40.0	2.21	1.93	1.66	1.38	1.10	0.83	36
30.0	3.06	2.68	2.30	1.91	1.53	1.15	26
20.0	4.78	4.18	3.59	2.99	2.39	1.79	17
10.0	9.98	8.73	7.49	6.24	4.99	3.74	8
	20	30	40	50	60	70	

R121/100 - R122/100 - R126/100

2CDC 302 010 F0004

R31x range

operational current I_b [A]	thermal resistance [K/W]						power dissipation P_V [W]
25.0	0.44	0.34	0.23	0.12	0.01	--	92
22.5	0.62	0.49	0.37	0.24	0.12	--	80
20.0	0.84	0.69	0.54	0.40	0.25	0.10	68
17.5	1.12	0.95	0.78	0.60	0.43	0.25	58
15.0	1.51	1.30	1.09	0.88	0.67	0.46	47
12.5	2.06	1.80	1.54	1.27	1.01	0.75	38
10.0	2.75	2.40	2.06	1.72	1.37	1.03	29
7.5	3.83	3.35	2.87	2.39	1.91	1.43	21
5.0	6.01	5.26	4.51	3.76	3.01	2.25	13
2.5	12.62	11.04	9.46	7.89	6.31	4.73	6
	20	30	40	50	60	70	80

R311/25 - R315/25

2CDC 302 001 F0005

operational current I_b [A]	thermal resistance [K/W]						power dissipation P_V [W]
55.0	0.29	0.23	0.17	0.11	0.05	--	164
50.0	0.36	0.29	0.22	0.16	0.09	0.02	148
45.0	0.44	0.36	0.29	0.21	0.14	0.06	133
40.0	0.54	0.46	0.37	0.29	0.20	0.12	118
35.0	0.67	0.58	0.48	0.38	0.28	0.19	103
30.0	0.85	0.74	0.62	0.51	0.39	0.28	87
25.0	1.10	0.96	0.82	0.68	0.55	0.41	73
20.0	1.38	1.21	1.04	0.87	0.69	0.52	63
15.0	1.85	1.62	1.39	1.16	0.93	0.70	43
10.0	2.80	2.45	2.10	1.75	1.40	1.05	29
5.0	5.62	4.92	4.21	3.51	2.81	2.11	14
2.5	11.26	9.85	8.45	7.04	5.63	4.22	7
	20	30	40	50	60	70	80

R311/55 - R315/55

2CDC 302 002 F0005

operational current I_b [A]	thermal resistance [K/W]						power dissipation P_V [W]
75.0	0.27	0.22	0.17	0.12	0.07	0.02	201
70.0	0.32	0.27	0.21	0.16	0.10	0.05	184
65.0	0.38	0.32	0.26	0.20	0.14	0.08	167
60.0	0.44	0.38	0.31	0.25	0.18	0.11	151
55.0	0.52	0.45	0.38	0.30	0.23	0.16	136
50.0	0.62	0.54	0.45	0.37	0.29	0.21	121
45.0	0.74	0.64	0.55	0.46	0.36	0.27	106
40.0	0.87	0.76	0.65	0.54	0.43	0.32	92
35.0	1.01	0.89	0.78	0.63	0.51	0.38	79
30.0	1.21	1.06	0.91	0.76	0.60	0.45	66
25.0	1.49	1.30	1.11	0.93	0.74	0.56	57
20.0	1.90	1.67	1.43	1.19	0.95	0.71	42
15.0	2.60	2.28	1.95	1.60	1.30	0.98	31
10.0	4.01	3.51	3.01	2.51	2.01	1.50	20
5.0	8.24	7.21	6.18	5.15	4.12	3.09	10
	20	30	40	50	60	70	80

R311/75 - R315/75

2CDC 302 003 F0005

Semiconductor contactor R100.xx and R300.xx Solid-state relays R111, R12x and R31x

Dimensional drawings

Dimensional drawings

Dimensions in mm

Semiconductor contactors

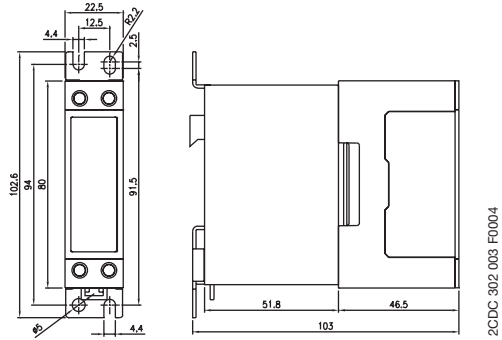

R100.20, R100.30

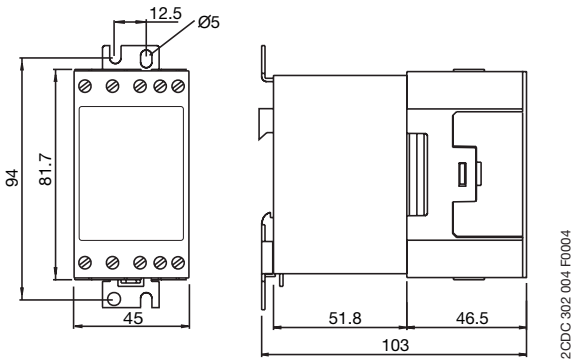

R100.45, R100.45-SG
R300.20

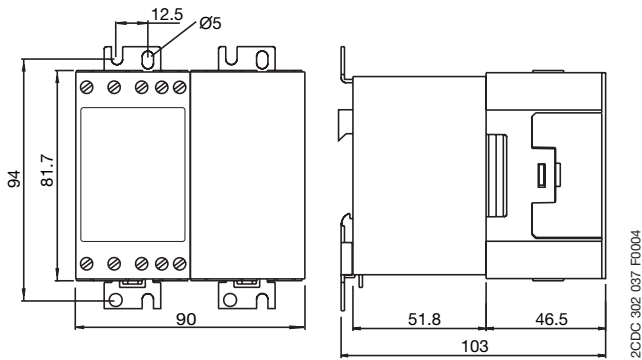

R300.25

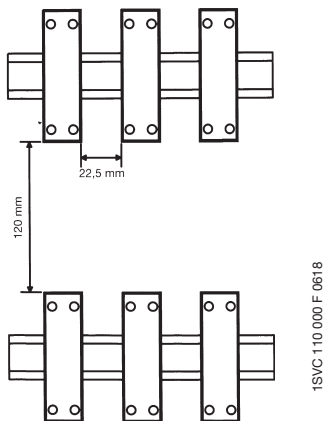

DIN rail mounting for R100.xx

Solid-state relays

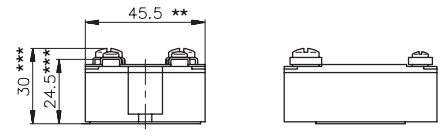

Use heat transfer compound!

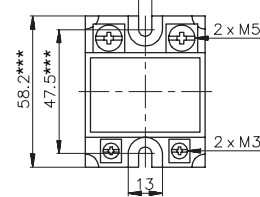

** = ±0.4 mm
*** = ±0.5 mm

R111

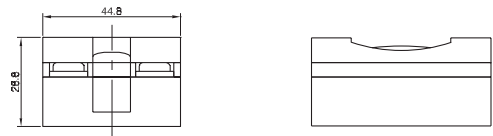

Use heat transfer compound!

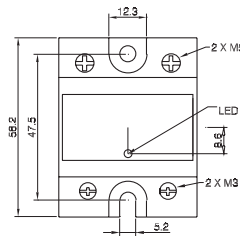

R120, R121, R122, R126

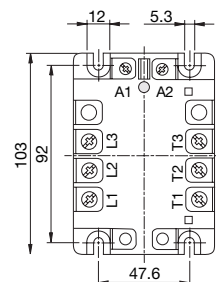
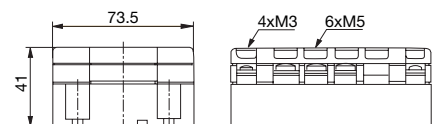

Use heat transfer compound!

R311, R315

Solid-state relays - Accessories

Heat sinks KK

Dimensional drawings

Dimensional drawings

Dimensions in mm

Heat sinks for screw mounting on a mounting plate for solid-state relays R111

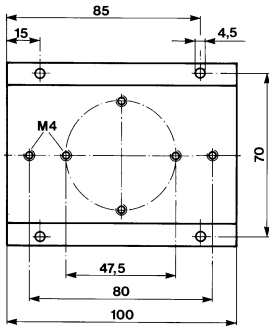

KK-1,8

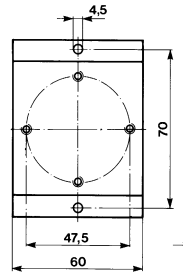

KK-2,6

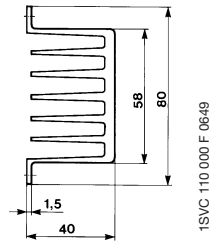

KK-1,8 / KK-2,6

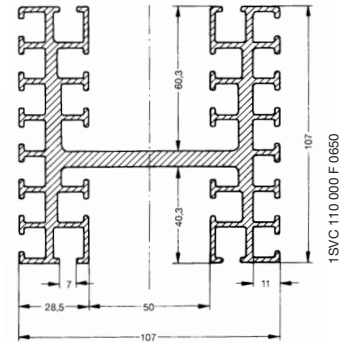

KK-0,7 (length 100 mm)

Heat sinks for DIN rail mounting

Dimensions, heat sink only

Type	W	D	H
KK-R111-2,1	51	65	65
KK-R111-1,5	45	65	97
KK-R111-0,7	72	75	136
KK-R111-0,5	120	100	136
KK-R311-0,8	114	75	130

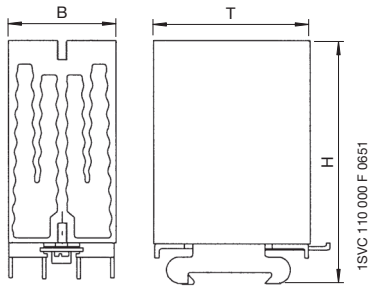

KK-R111-2,1

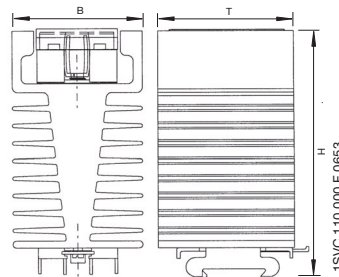

HS 50/0,7 - HS 75/0,7
HS100-0,7 - KK-R111-0,7

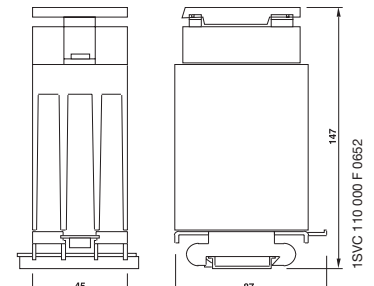

HS 50/1,5 - HS 50-AC/1,5
HS 50-H/1,5 - HS 75/1,5
KK-R111-1,5

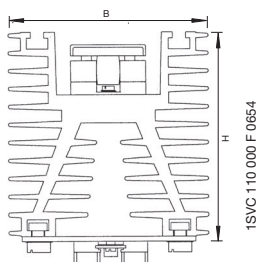

HS 100-0,5 - HS 75/0,5
HS 90/0,5-AC - KK-R111-

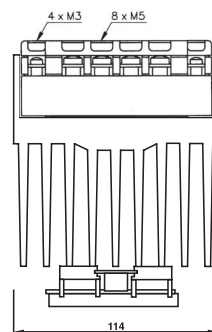

HDS 50/0,8 - HDS 50-AC/0,8
KK-R311-0,8

